



# CHEMICAL AND PHARMACEUTICAL APPLICATIONS



Precision on-line  
and at-line NIR  
moisture  
measurements

- ▶ Enhance Product Quality
- ▶ Improve Production Efficiency
- ▶ Reduce Fossil Fuel Consumption
- ▶ Achieve Right-first-time Batch Drying

# NDC & the Chemicals and Pharmaceutical Industries

With over 40 years' experience in the development and manufacture of process instrumentation for industry, our philosophy has been to combine leading edge instrument design with the best in applications engineering, complemented by a range of supporting products to bring the measurement to the process.

We believe that each application or process has special requirements, and that only a complete measurement solution can achieve results.

With an on-line measurement pedigree spanning 8 generations of analyzers, our NDC CM710e Industrial Moisture Gauges, PH710e Pharmaceutical Moisture Gauges and InfraLab Benchtop Moisture Analyzers have been developed specifically to meet the exacting needs of industrial processes.

With a database of over 3,000 different application records representing many thousands of data points comparing NDC On-line Gauges to compendial methods, we are certain that the robustness of our measurements makes our instruments completely dependable for quality and process control.



[www.ndc.com/chemicals](http://www.ndc.com/chemicals)  
[www.ndc.com/pharma](http://www.ndc.com/pharma)

# The Need for Quality & Process Control

## Using accurate moisture control to improve product quality & process efficiency

### Measurements:

#### ► Moisture Content

- Powders & Granules
- Flakes
- Slurries

### Applications:

- Chemicals
- Detergents
- Fertilizers
- Pharmaceuticals
- Nutraceuticals

**Automated process control** using real-time on-line moisture measurement is a primary objective for many processes, in order to achieve consistently optimal product quality, to meet required product flow or compression characteristics, or to ensure the product can be correctly stored or transported prior to end use.

In addition to product quality, moisture content greatly impacts process efficiency and yield: whether achieving the correct end-point moisture prior to tableting, monitoring moisture in a slurry before the spray dryer, or using feedback control at the dryer exit to optimize moisture – these and many other processes can benefit from tighter control of moisture levels.

**Measurements must be robust enough** for the process environment and accurate and reliable enough to be trusted for control. The process may also demand specifically engineered solutions to gain access to the product to make an effective measurement.

While many products are transported on conveyors providing convenient measurement access, pneumatic transport systems will require automatic samplers; discontinuous product flows require product presence/absence detection; and measurement may also be required through a sight glass.

We offer a range of well engineered solutions to ensure that the measurement can be made where and when you need it.

**InfraLab Moisture Analyzer:**



**CM710e Moisture Gauge:**



**PH710e Pharmaceutical Gauge:**



# The CM- and PH710e Moisture Gauges

**Long-term calibration stability** – why Series 710e Gauges are trusted for control...

**CM710e with Standard IP65 Cast Alloy Housing ▼**



**CM710e with IP65 Stainless Steel Housing with optional Vortec air cooling ▼**



The CM710e on-line industrial moisture Gauge uses precision NIR (near infrared) measurement technology to make a continuous non-contacting measurement of moisture in the process.

With a measurement speed of 7.5 milliseconds, the patented “light engine” uses optical components manufactured in NDC’s own optics facility, to deliver the highest resolution on-line NIR measurements available today.

The CM710e can be incorporated conveniently into closed-loop control systems. Its connectivity options include:

- ▶ Digital
- ▶ Analog
- ▶ Industrial Ethernet
- ▶ Fieldbus

## CM710e: Key Features & Options

- ▶ **Series 710e Devices**  
for interfacing, connectivity and networking
- ▶ **Ethernet, Fieldbus and analog connectivity**  
options for networking and integration
- ▶ **IP65 & IP67 housings**  
cast alloy or stainless steel
- ▶ **Auto reference standard**  
for routine stability checks and standardization after source change
- ▶ **Air and water cooling**  
options for > 50° C ambient temperatures
- ▶ **PowderVision xampler**  
for products in enclosed ducts
- ▶ **Air Purge Window Shield**  
for dusty or steamy atmospheres
- ▶ **ATEX certified system**  
for dust hazard areas

## PH710e: Additional Features

The PH710e uses a modified version of the CM710e housing shown above and features:

- ▶ **316 stainless steel housing**  
ATEX 3D Zone 22 rated
- ▶ **Glanded single multi-core cable to gauge**
- ▶ **User Port**  
with digital and analog connectivity to facilitate integration into client network or connection to PLC. Power is also input to the User Port and fed to the gauge

Using industry-standard Ethernet communication hardware such as hubs, cables, repeaters and routers, installation and integration of the modular CM710e gauging system is straightforward.

For network integration, the Gauge can be configured for the following industrial Ethernet protocols:

- ▶ EtherNet IP
- ▶ PROFINET
- ▶ Modbus/TCP

If Fieldbus connectivity is required, the OWS, HMI and User Port can be supplied with Network Gateways for:

- ▶ PROFIBUS DP
- ▶ DeviceNet
- ▶ CANbus Open



# 710e Devices and Networks

**Convenient interfacing:** what you need, where you need it

Easy to install, integrate and operate, the CM710e is the most flexible in-process gauging system available...

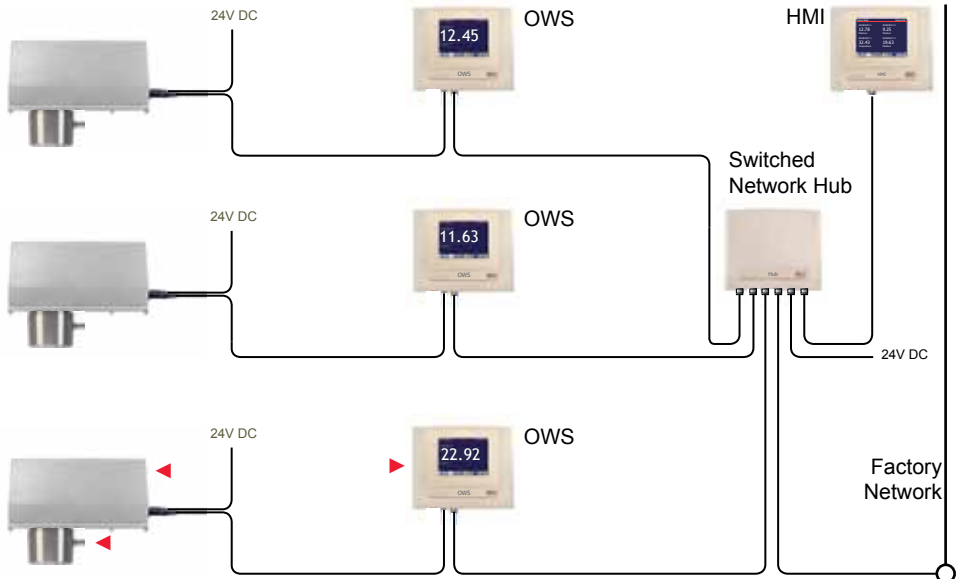

► The NDC CM710e recommended moisture gauge configuration comprises: **Stainless Steel Sensor Housing, Air Purge Window Shield & Operator Workstation**

## 710e HMI



- ¼ VGA color touchscreen
- Analog and Ethernet connections
- Controls up to 16 gauges
- Multi-lingual interface

## 710e Devices

Series 710e Peripheral Devices available include:

- **OWS: Operator Workstation**
- **HMI: Human Machine Interface**
- **User Port**
- **Switched 7-Way Switched Hub**

The OWS provides operator-level interaction with an individual gauge with access to sampling and diagnostic functions.

The HMI provides supervisory access to up to 16 networked CM710e gauges to enable gauge set-up, calibration adjustment, and product management, with analog and digital connectivity as well as network access. Both HMI and OWS feature high definition multi-lingual color touchscreen displays.

The User Port provides additional analog outputs and digital I/O for any connected gauge. The Switched Network Hub enables convenient networked arrangements of multiple 710e gauges and devices, with its 7 network connections.

For simplicity and convenience, all CM710e gauges and devices run on **24V DC**, either from an on-site supply or from an NDC in-line 24V universal power supply.

Long-term stability combined with industry-best performance, low installation costs and no routine maintenance requirements guarantee the **lowest cost of ownership** over the CM710e's many years of service.

# The CM710e in the Process

Fully engineered for continuous or discontinuous product flows

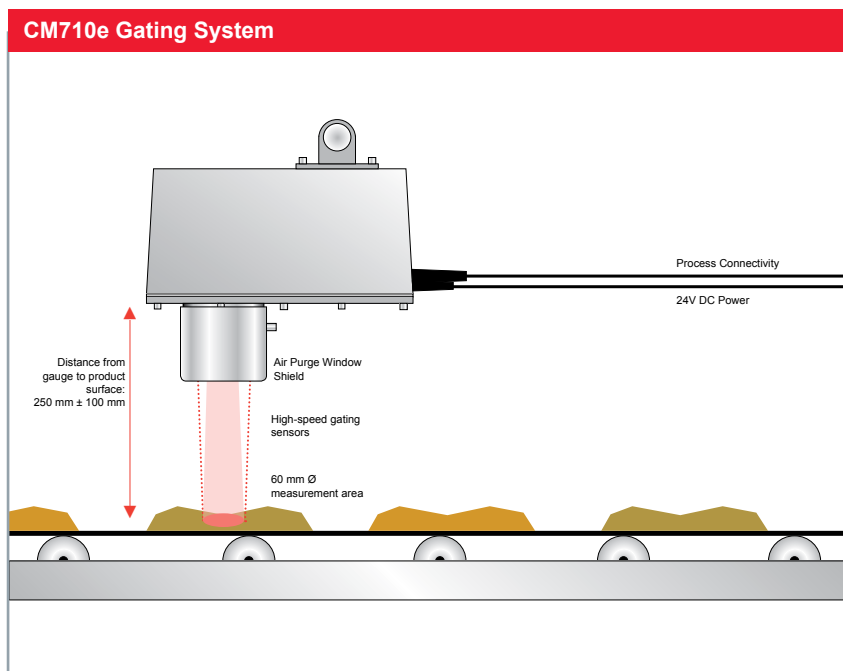
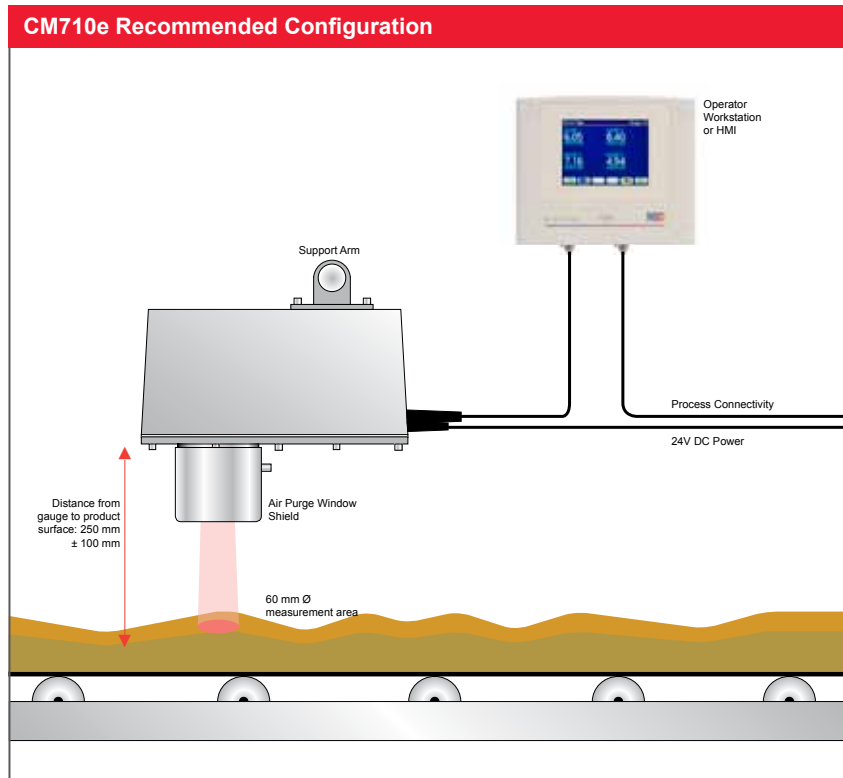

## Installation

The CM710e measures over a 60 mm diameter area and is suspended over the process line at a distance of 250 mm from the mean product height to the CM710e measurement window.

The gauge tolerates product height fluctuations of  $\pm 100\text{mm}$ , without the measurement being affected.

Ambient lighting, temperature or relative humidity changes do not affect the CM710e measurement.

## Process Conditions



TEMPERATURE



DUST



AMBIENT LIGHT



HUMIDITY

The CM710e's alloy & optional stainless steel housings are sealed to IP65 and can operate in ambient temperatures from 0° to 50° C without cooling. The stainless steel housing is also available in IP67 and ATEX certified versions. A vortex cooler attachment or insulated air-cooled housing are available for ambient temperatures exceeding 50° C. The optional Air Purge Window Shield connects to a clean air supply to create a positive air pressure in front of the measurement window to prevent contamination.

## Discontinuous Product Flows

The optional integrated "high-speed gating" system detects the product's presence or absence in discontinuous flows and avoids recording of data when nothing is passing across the measurement area.

# The CM710e & PH710e in the Process

Used with a PowderVision sampler in gravity-fed product flows

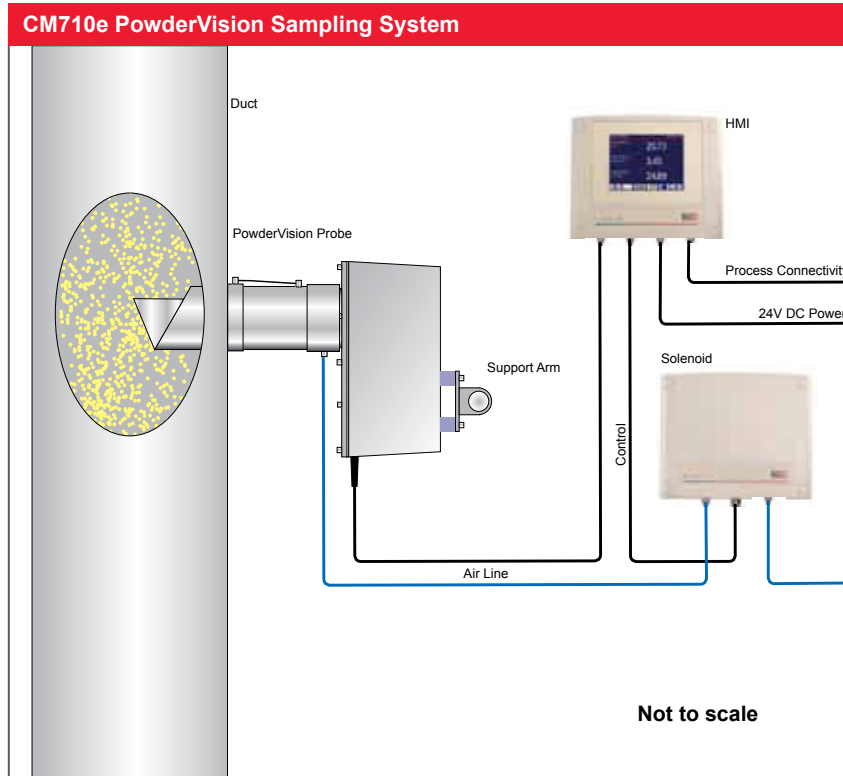

## Powders in gravity-fed ducts

For powders transported in enclosed ducts, the pneumatic PowderVision sampler is used. The device comprises a tube fitting with window and sample collection cup. The cup fills with the falling product and, after a sample has been collected and measured, a jet of air ejects it and the cycle recommences.

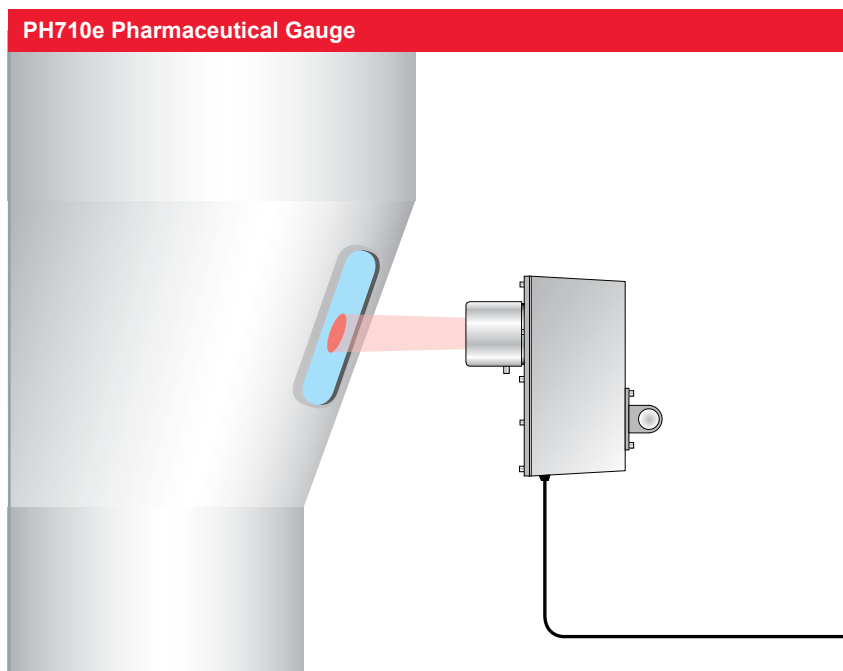

## Pharmaceutical powders in fluid bed dryers

The PH710e pharmaceutical moisture gauge can be installed to measure moisture in powders in a fluid bed dryer through a sight glass, while ensuring that the measurement area is below the powder line.

For powders which adhere to the sight glass, ask about NDC's novel and unique cleanable fiber probe solution.

# The InfraLab Moisture Analyzer

Fast, accurate and easy to operate, the InfraLab makes short work of sample testing

## Key Features

- ▶ **Color VGA display** touchscreen user interface
- ▶ **InfraLab Manager software** for data management via PC
- ▶ **Ethernet and LIMS** connectivity
- ▶ **On-board data storage** of up to 10,000 sample measurement files
- ▶ **Up to 200 users** each with identifying pass code
- ▶ **Product database** for up to 200 products with unique settings for each
- ▶ **USB data port** for data download to spreadsheet programs
- ▶ **Barcode reader option** making log-in and product selection even easier
- ▶ **Reference standard** for routine stability checks and standardization after servicing
- ▶ **Choice of sample bowl size** deep, shallow (rotating) or petri-dish (static)

**The InfraLab e-Series moisture analyzer** is designed for at-line or laboratory use and measures samples taken from the process in less than 10 seconds.

InfraLab is designed as a routine replacement for loss-on-drying, Karl Fischer titration or gravimetric moisture testing.

Once calibrated to the preferred reference methods, a process facilitated by the InfraLab Manager software, its key advantages are: speed, minimal sample preparation and the fact that it measures a larger, more representative sample than other techniques.

Once set up, InfraLab is accessed via its intuitive interface and requires no special user skills in routine use.

### Secure data storage

In addition to its speed and precision, InfraLab benefits from substantial data storage and security features.

The time and date of every measurement are recorded along with the name of the operator who is logged in at the time.

### 5 year consumables warranty

The source lamp and motor are guaranteed for 5 years and can be exchanged quickly and easily on site without intervention from NDC.

**Ethernet connectivity** enables InfraLab to be used either as a standalone analyzer or integrated into LIMS or factory networks, or simply connected to a PC when required to take advantage of the features offered by the InfraLab Manager software.

### InfraLab Manager software

provides user access to all measurement and calibration data and enables set-up and remote access to data and key functions. It enables up to 16 networked analyzers to be controlled and viewed centrally from a PC.



▶ **Standard large bowl**



# At-Line in the Process Area or in the Laboratory

Access data quickly and easily via Ethernet or the USB download function



► InfraLab shown with optional petri-dish adapter

InfraLab delivers substantial savings through increased speed and reduced costs of routine sample testing...

## InfraLab Manager Software

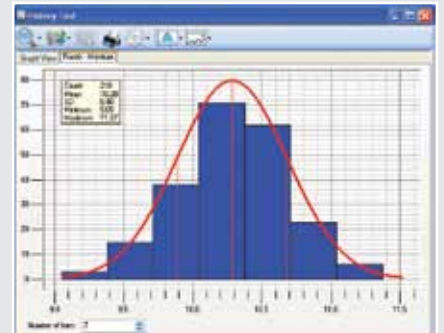

► Histogram



► Data display

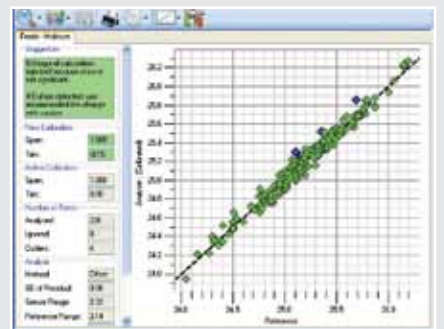

► Calibration

# Applications

Comprehensive applications engineering for high performance process measurements

NDC Chemical and Pharmaceutical Applications		
Industry sector	Moisture	Application Areas
Chemicals	✓	aluminum hydroxide, alumina/aluminum oxide, amino acid powder, ammonia oxide, ammonium/potassium chloride, boric acid, bromine, calcium carbonate, ferrite powder, sodium chloride (salt), sodium carbonate/bicarbonate, sodium sequecarbonate, sulphur, titanium dioxide paste/powder, uranium dioxide
Detergents	✓	detergent powders: zeolite, phosphate or carbonate based detergent slurries: phosphate or zeolite based
Fertilizers	✓	ammonium, phosphate or nitrate based
Pharmaceuticals & Nutraceuticals	✓	pharmaceutical & nutraceutical powders, sugar coatings in the pan coater

## Measurement Ranges and Calibration

Recognizing that there can be no such instrument as a "generic" moisture analyzer, our CM710e & PH710e Gauges and the InfraLab Analyzer are all supplied with a factory pre-calibration which covers the required moisture range. The pre-calibrations are based on our extensive applications engineering history and are designed to require the minimum of adjustment to achieve agreement with your laboratory primary reference technique.

The GaugeToolsXL (for CM-/PH710e) and InfraLab Manager software provided simplifies this process by enabling comparison of instrument values with laboratory results and feature the following tools and functionality:

- ▶ Instrument Set-up and Calibration
- ▶ Product Management (Product Settings)
- ▶ Displays of Measurement and other Key Parameters
- ▶ Data Logging and Data Trending & Export
- ▶ Diagnostic Functions
- ▶ OPC Server (optional)

Thanks to their Ethernet connectivity, in many instances, the instruments can be interrogated and communicated with via the internet to provide diagnostics, updates and other support functionality.

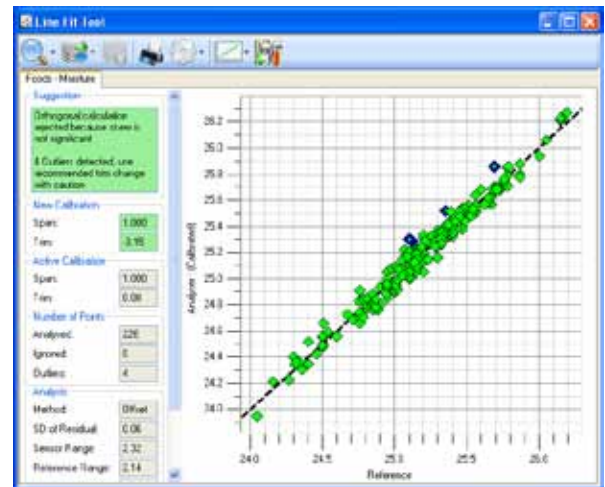

For applications in minerals and other bulk materials consult the Minerals and Bulk Materials brochure.



# Company Overview

## Combining industry-best performance and reliability with a global support structure

NDC, headquartered in Irwindale, California, USA, develops and manufactures measurement and control systems for a wide range of industrial applications, supporting its global customer base through its three centers of excellence:

- ▶ USA (for scanning profile display and control systems or the web industries)
- ▶ UK (for infrared gauging and applications development)
- ▶ Belgium (for metal industry gauging systems)

There are also direct sales and customer support operations in China, Japan, Germany, France, Italy, Singapore and India.

The company's global client base features some most successful manufacturers, who rely on NDC to ensure that their product quality and performance meet the stringent standards demanded by their customers.

### NDC has two key product groups:

**NDC Systems:** for the converting, extrusion, calendering, metals and nonwovens industries, delivering real-time measurement and control of key product parameters such as product thickness, coating thickness, basis weight, width, flatness and edge shape.

**NDC Sensors:** on-line gauges and at-line analyzers for the measurement of moisture and other key product constituents in the food, chemical, pharmaceutical, mineral, bulk materials and tobacco industries.

NDC is part of Spectris plc, the leading supplier of productivity-enhancing instrumentation and controls.



NDC is represented in over 60 countries worldwide. ISO9001:2008 [www.ndc.com](http://www.ndc.com)

a **spectris** company

**NDC Infrared Engineering Inc**  
Tel: +1 626 960 3300  
Email: [enquiries@ndcinfraed.com](mailto:enquiries@ndcinfraed.com)

**NDC Infrared Engineering S.A.**  
Tel: +32 4 239 90 10  
Email: [info@ndcinfraed.be](mailto:info@ndcinfraed.be)

**NDC Japan**  
Tel: +81 3 3255 8157  
Email: [info@ndcinfraed.jp](mailto:info@ndcinfraed.jp)

**NDC France**  
Tel: N° Azur: 0810 600 400  
Email: [info@ndcinfraed.fr](mailto:info@ndcinfraed.fr)

**NDC Singapore**  
Tel: +65 9199 4120  
Email: [apacsales@ndc.com](mailto:apacsales@ndc.com)

**NDC Infrared Engineering Ltd**  
Tel: +44 1621 852244  
Email: [sales@ndcinfraed.co.uk](mailto:sales@ndcinfraed.co.uk)

**NDC China**  
Tel: 86 20 2887 3860  
Email: [info@ndcinfraed.com.cn](mailto:info@ndcinfraed.com.cn)

**NDC Germany**  
Tel: +49 1801 977112  
Email: [info@ndcinfraed.de](mailto:info@ndcinfraed.de)

**NDC Italy**  
Tel: +39 0331 454 207  
Email: [info@ndcinfraed.it](mailto:info@ndcinfraed.it)

**NDC India**  
Tel: +91 9890 800 697  
Email: [ndcindia@ndc.com](mailto:ndcindia@ndc.com)

In line with its policy of continuous improvement, NDC reserves the right to revise or replace its products or services without prior notice. The information contained in this document may not represent the latest specification and is for indicative purposes only.

Ref: 03-15439 - 02 - 2013-04 - Chemicals and Pharma Brochure - English - 2013  
Date of Issue: April 2013  
© NDC 2013

